



SE Spezial-Electronic GmbH

LVIV-B2

Bluetooth Module Series



Figure 1a – P/N: SE-NOBS-B2*-A3 *prototype* (top view)

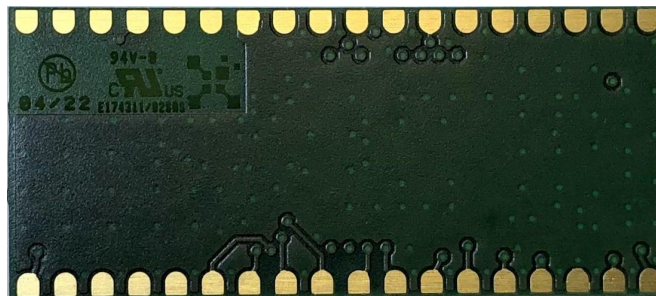

Figure 1b – P/N: SE-NOBS-B2*-A3 *prototype* (bottom view)

Electrical and Mechanical Data Sheet



Abstract

LVIV-B2 Series modules are SMT mountable Bluetooth / Bluetooth Low Energy modules that add wireless communication in the 2.4GHz ISM band to electronic devices for professional use.

The module is configured and controlled by AT commands via a serial UART interface. The same interface can be used for data communication.

LVIV-B2 Series modules are available with an integrated antenna or with an U.FL connector for use of an external antenna. The module cannot be operated as a stand-alone device.

LVIV-B2 Series modules have been developed as a SMT mountable drop-in replacement for u-blox' popular OBS4** module series.

LVIV-B2 design is mechanically the same as OBS4** modules:

- same mechanical size
- same SMT mount pads
- same antenna design for internal antenna

Host CPU software interface needs to be re-designed, as the NINA-B221 module has a different AT command set compared to OBS4** series modules.

LVIV-B2 modules are *not recommended for new designs*. For new designs, please consider u-blox NINA-B221 or NINA-B222.

Document Information

Document Name:	se_lviv-b2_datasheet_r10.docx
Document Revision:	R10
Revision Date:	16/05/2023
Document Status:	released
LVIV-B2 PCB Revision:	SE18062021_1V01
LVIV-B2 product status:	Series Production



Content

Abstract	2
Document Information	2
Related Documents.....	6
Terms and Abbreviations used in this document	6
Block Diagram.....	7
LVIV-B2 Product Variants & Part Numbering Scheme	8
Product variants	8
Part Numbering Scheme LVIV-B2 Series Modules:	9
Electrical Interface and Solder Pads	10
OBS4** (for reference only)	10
LVIV-B2:	10
Pin Description for module SMT interface J6	11
OBS4** to LVIV-B2 Migration	13
Supported Communication Interface	13
Limitations.....	13
Differences	13
Switch 1:	13
Switch 1 AND Switch 2:	13
UART default settings.....	14
Supported UART Baud rates	14
Mechanical Design	15
LVIV-B2 Antenna Design	15
P/N: SE-NOBS-B2x (external Antenna):.....	15
P/N: SE-NOBS-B2i (internal Antenna):	16
Radio Characteristics.....	16
Bluetooth.....	16
Bluetooth Low Energy	16
Output Power Control.....	16
Antenna gain.....	17
External antenna:	17
Internal antenna:.....	17



Power Supply	17
Power Supply Input.....	17
Power Output for Level Shifter.....	17
Electrical Interface.....	17
Physical Dimensions.....	18
Mounting	18
ESD Handling Precautions.....	19
Soldering.....	19
Recommended Temperature Profile.....	20
Environmental Information	20
RoHS directive.....	20
REACH directive.....	20
Flammability	20
Product Label Information.....	21
Qualification and Approvals.....	22
European Union regulatory compliance	22
Radio Equipment Directive (RED) 2014/53/EU	22
Output power limitation	22
Output power:	23
Compliance with the RoHS directive	23
United States (FCC)	24
FCC compliance	24
2.2.2 FCC statement	25
RF-exposure.....	26
End-product compliance.....	27
Canada (ISED)	28
Canada (ISED)	28
RF-exposure.....	28
Japan radio equipment compliance	30
Compliance statement.....	30
End product labelling requirement.....	30
End product user manual requirement.....	30



UL Marking	31
Radio Test Access	32
Document Revision History	33
Manufacturer Contact.....	33
Technical Support	33
Appendix A: u-blox Documentation NINA-B2 and OBS421	34
Appendix B: Tape & Reel Packaging Information.....	35
Appendix C: Approved antennas.....	36
Onboard antenna (SE-NOBS-B2i-**)	36
External antennas with U.FL connector	37
External antennas with U.FL connector	37
External antennas with SMA connector	37
External antennas with RP-SMA connector	38
Adapter Cables	38
U.FL to SMA adapter cable	38
U.FL to Reverse Polarity (RP) SMA.....	38
Appendix D: Indicative Performance internal antenna (P/N: SE-NOBS-B2i-B3)	39
Data Throughput Classic Bluetooth SPP (all default):.....	39
Data Throughput Classic Bluetooth SPP (3Mit/s UART):	39
Data Throughput Bluetooth Low Energy SPS:	39
Range classic BT (SPP, residential road, restricted line of sight):	40
Appendix E: P/N comparison LVIV-B2 / OBS4**	41



Related Documents

As the basic functionality of LVIV-B2 modules is based on u-blox NINA-B221 module, most of the technical documentation is based on the NINA-B2 documentation. This data sheet contains some basic information, especially focusing on the differences between NINA-B2 and LVIV-B2.

Complete technical documentation for u-blox NINA-B221 module on u-blox website:

<https://www.u-blox.com/en/product/nina-b2-series-u-connect?lang=de#tab-documentation-resources>

Complete technical documentation for u-blox OBS421 module on u-blox website:

<https://www.u-blox.com/en/product/obs421-series?lang=de#tab-documentation-resources>

The above NINA-B2 documents from u-blox must be regarded as part of LVIV-B2 documentation.

For a more complete list of related documents, please refer to [Appendix A](#).

Terms and Abbreviations used in this document

LVIV-B2	Product Series Name
NOBS	N INA-B2 to OBS 4** Adapter
BT	Bluetooth
BTLE	Bluetooth Low Energy
OBS4**	representing u-blox OBS module family OBS418, OBS419, OBS421
P/N	part number to differentiate variants of LVIV-B2
s-center	u-blox Test Software for NINA-B2 modules
SMT	surface mount technology
UART	universal asynchronous receiver / transmitter "serial interface"



Block Diagram

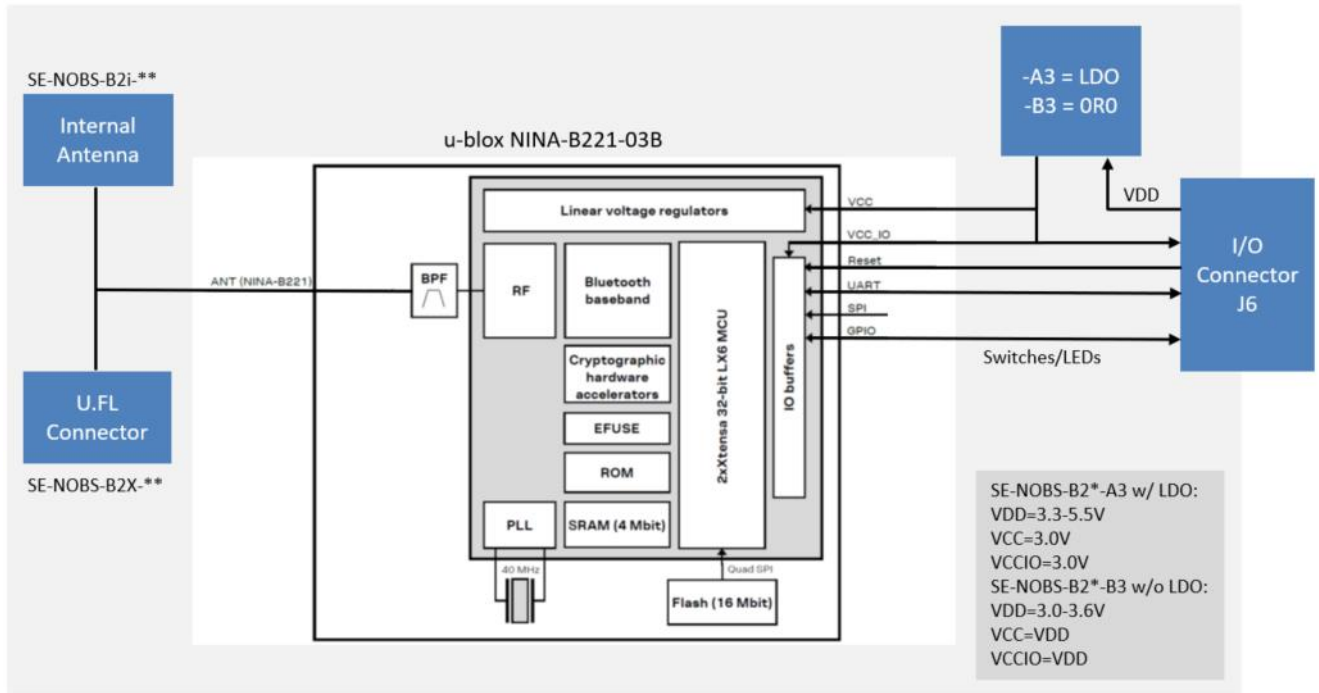

Figure 2 – LVIV-B2 block diagram

- P/N SE-NOBS-B2*-A* integrated LDO
- P/N SE-NOBS-B2*-B* no LDO, supply voltage directly connected to NINA-B221
- P/N SE-NOBS-B2i-** internal antenna
- P/N SE-NOBS-B2X-** U.FL connector for external antenna



LVIV-B2 Product Variants & Part Numbering Scheme

Product variants

LVIV-B2, 3.3-5.5V supply voltage, internal antenna

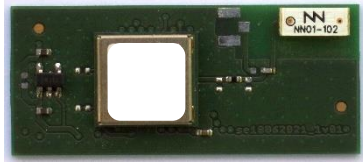
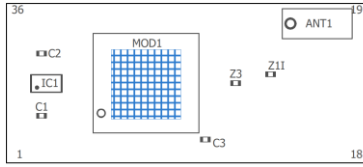

LVIV-B2 Product Label

Figure 3a

P/N: SE-NOBS-B2i-A3

- NINA-B221-03B (Firmware 4.0.0-003)
- internal Antenna
- supply voltage range 3,3-5,5V DC
- interface voltage 3,0V (fixed)

LVIV-B2, 3.3-5.5V supply voltage, external antenna

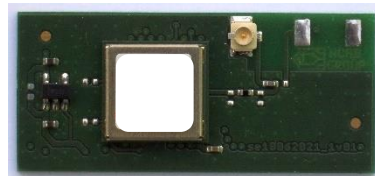
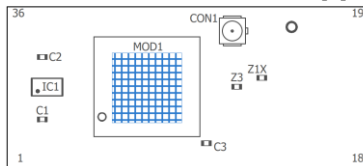

LVIV-B2 Product Label

Figure 3b

P/N: SE-NOBS-B2X-A3

- NINA-B221-03B (Firmware 4.0.0-003)
- U.FL connector for external Antenna
- supply voltage range 3,3-5,5V DC
- interface voltage 3,0V DC (fixed)

LVIV-B2, 3.0-3.6V supply voltage, internal antenna

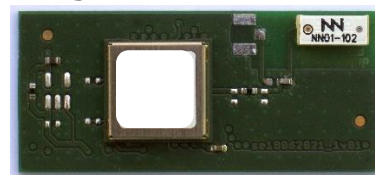
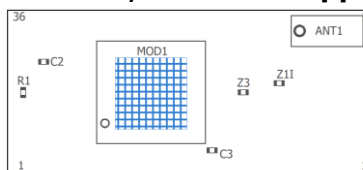

LVIV-B2 Product Label

Figure 3c

P/N: SE-NOBS-B2i-B3

- NINA-B221-03B (Firmware 4.0.0-003)
- internal Antenna
- supply voltage range 3,0-3,6V DC
- interface voltage = same as supply voltage



LVIV-B2, 3.0-3.6V supply voltage, external antenna

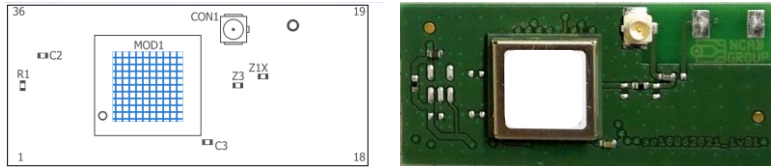

LVIV-B2 Product Label

Figure 3d

P/N: SE-NOBS-B2X-B3

- NINA-B221-03B (Firmware 4.0.0-003)
- U.FL connector for external Antenna
- supply voltage range 3,0-3,6V DC
- interface voltage = same as supply voltage

Part Numbering Scheme LVIV-B2 Series Modules:

SE-NOBS-B2a-hm

- SE -> **SE** Spezial-Electronic GmbH
- NOBS -> **N**INA to **OBS** Adapter
- B2 -> based on u-blox NINA-**B221**
- a -> antenna type: **i** = internal, **X** = external
- h -> Supply voltage: **A** = 3,3-5,5V, **B** = 3,0-3,6V
- m -> NINA-B2 module revision: 3 represents NINA-B221-0**3B**, ...

Options can't be selected by customers. Available product variants are limited to the above list.



Electrical Interface and Solder Pads

OBS4** (for reference only)

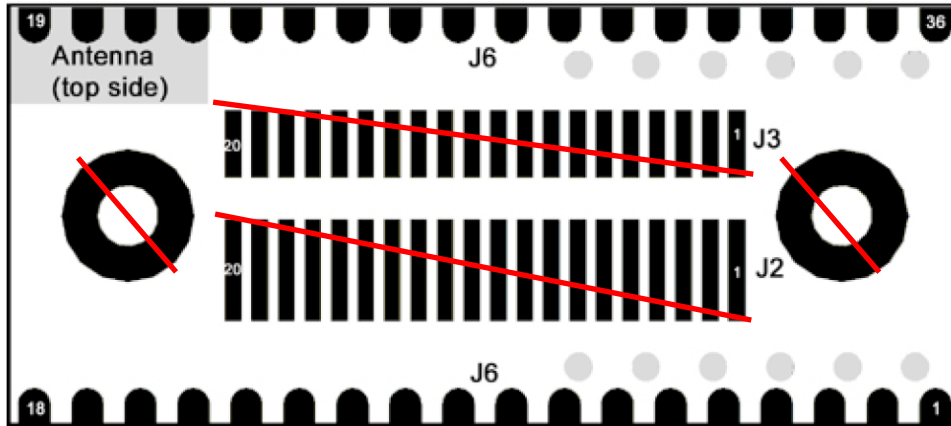

Figure 4 – Bottom view of u-blox OBS4** modules

Full description of mechanical appearance can be found in OBS421 data sheet.

LVIV-B2:



Figure 5 – Bottom view of SE LVIV-B2 module

Please note, connector rows J2, J3 and J8 (JST connector on Top side of OBS4**) are not available on LVIV-B2 modules, as well as the screw holes. LVIV-B2 is designed for SMT soldering only.

PCB size and solder pads of LVIV-B2 modules are the same as on OBS4** modules.



Pin Description for module SMT interface J6

OBS4**			LVIV-B2*			
SMT PAD	Signal	Remark		SMT PAD	Signal	Remark
1	RESET_N		identical	1	RESET_N	
2	VCC_2V85 (out)	Output 2,85V	VCCIO changed	2	VCC_3V0 (out)	Please check design compatibility
3	GND		identical	3	GND	
4	VCC_3V3 (in)	Supply 3,0-6,0V	reduced voltage supply range	4	VCC_3V3 (in)	Please check for correct module version
5	DTR (out)		identical	5	DTR (out)	
6	Switch-0		Different functionality	6	Switch-2	Check Firmware
7	RED / Mode		identical	7	RED / Mode	
8	GREEN / Switch-1		Same basic functionality	8	GREEN / Switch-1	Check Firmware
9	BLUE		identical	9	BLUE	
10	CTS (in)		identical	10	CTS (in)	
11	TxD (out)		identical	11	TxD (out)	
12	RTS (out)		identical	12	RTS (out)	
13	RxD (in)		identical	13	RxD (in)	
14	RSVD		not connected	14	n.c.	
15	RSVD		not connected	15	n.c.	



OBS4**			LVIV-B2*			
SMT PAD	Signal	Remark		SMT PAD	Signal	Remark
16	RSVD		not connected	16	n.c.	
17	RSVD		not connected	17	n.c.	
18	DSR (in)		identical	18	DSR (in)	
19	RSVD		not connected	19	n.c.	
20	RSVD		not connected	20	n.c.	
21	RSVD		not connected	21	n.c.	
22	RESET_N		identical	22	RESET_N	
23	GPIO 10	(default = high)	not connected	23	n.c.	!
24	GPIO 11	(default = high)	not connected	24	n.c.	!
25	GND		identical	25	GND	
26	GPIO 12	(default = high)	not connected	26	n.c.	!
27	GPIO 13	(default = high)	not connected	27	n.c.	!
28	GPIO 14	(default = high)	not connected	28	n.c.	!
29	RSVD		not connected	29	n.c.	!
30	DSR (in)		identical	30	DSR (in)	
31	GPIO 15	(default = high)	not connected	31	n.c.	!
32	GPIO 16	(default = high)	not connected	32	n.c.	!
33	GPIO 17	(default = high)	not connected	33	n.c.	!
34	GPIO 18	(default = high)	not connected	34	n.c.	!
35	serial select 1	RS485 management	RS485 management not implemented	35	n.c.	!



OBS4**			LVIV-B2*			
SMT PAD	Signal	Remark		SMT PAD	Signal	Remark
36	serial select 0	RS485 management	RS485 management not implemented	36	n.c.	!

Table 1 – physical interfacel comparison OBS4** vs. LVIV-B2

OBS4** to LVIV-B2 Migration

Supported Communication Interface

- 6 wire CMOS UART interface is fully supported
- RESET input is supported (low active)
- u-blox push button interface is supported -> different functionality
- u-blox status LEDs are supported

Limitations

- Supply voltage range and I/O voltage is different (see variants)
- GPIOs are not supported by LVIV-B2 modules
- I²C bus (iAP interface) is not supported by LVIV-B2
- RS485 management is not supported by LVIV-B2

Differences

Please be aware that function switches are different for OBS4** and LVIV-B2:

Function / Name	LVIV-B2	OBS4**	NINA-B221
Switch 0	(not available)	Pin 6	(not available)
Green / Switch 1	Pin 8	Pin 8	Pin 7
Switch 2	Pin 6	(not available)	Pin 18

Table 2 – switch signal comparison OBS4** vs. LVIV-B2

Switch 1:

If only signal „Switch 1“ is connected to GND during boot process, all UART settings (e.g. Baudrate, flow control, ...) are restored to factory default setting.

⇒ This is the same function as with OBS4**

Switch 1 AND Switch 2:

If both signals „Switch 1“ and „Switch 2“ are connected to GND during boot process for less than 10 seconds, LVIV-B2 module enters bootloader for firmware update.



If both signals „Switch 1“ and „Switch 2“are connected to GND during boot process for longer than 10 seconds, all user settings are restored to factory defaults.

⇒ This function is different. Please check the application firmware to avoid that the module may be set to boot mode!

UART default settings

Parameter	LVIV-B2	OBS421	Remarks
Baudrate	115200 Bd	57600 Bd	different
Data Bits	8 Bits	8 Bits	
Parity	No Parity	No Parity	
Stop Bits	1 Stop Bit	1 Stop Bit	
H/W flow control	enabled	enabled	
Escape Sequence	+++	///	different

Table 3 – UART default setting comparison OBS4** vs. LVIV-B2

Supported UART Baud rates

	LVIV-B2	OBS421
Standard Baud rate	9600, 14400, 19200, 38400, 57600, 115200 , 230400, 460800, 921600	1200, 2400, 4800, 9600, 19200, 38400, 57600 , 115200, 230400, 460800, 921600
Non-Standard Baud rate	28800, 250000	7200, 31250, 75000, 93750, 136000, 187500, 230000, 125000, 625000

Table 4 – UART Baudrate comparison OBS4** vs. LVIV-B2



Mechanical Design

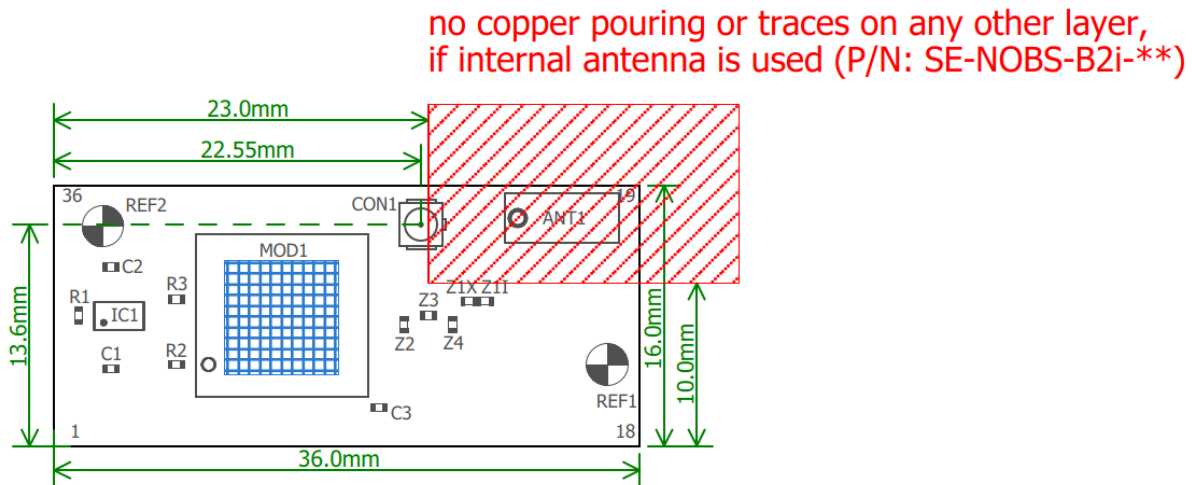

Figure 6 – mechanical information LVIV-B2

LVIV-B2 series module is designed to be a mechanically 1:1 replacement for SMT mounted OBS4** modules. Mechanical size of the PCB and solder contacts on the bottom side are identical to OBS4** modules.

Please refer to OBS4** data sheet – chapter 5 – for detailed drawings and measures.

LVIV-B2 has a max. height of 3.4mm for all variants, including internal antenna.

Internal Antenna is placed at the same place as on OBS4** modules, using the same antenna and GND design. This allows direct replacement – no new RF design is needed.

Connector for external antennas is U.FL, same type as on OBS4** modules. The connector is placed on the same location as on OBS4** modules – cable length for existing external antenna solutions will remain the same.

LVIV-B2 Antenna Design

P/N: SE-NOBS-B2x (external Antenna):

To connect any external antenna, a U.FL connector is used. The connector is located at almost the same place as on OBS4** modules (shifted by 0.05mm).

If external antenna option is used, there are no layout constraints.

For a list of already approved antennas, please refer to [Appendix C](#).



P/N: SE-NOBS-B2i (internal Antenna):

Internal antenna on LVIV-B2 is the same type as on OBS4** modules (Ignion NN01-102), located in the same place.

NOTE: LVIV-B2 does not use the same internal antenna as NINA-B222 module. The internal antenna information (including radiation patterns) from NINA-B222 data sheet does not apply for LVIV-B2 (P/N SE-NOBS-B2i-**).

LVIV-B2 with internal antenna uses Ignion NN01-102 antenna – same as u-blox OBS4** modules. Due to the usage of the OBS4**i antenna type, location and copper design, the same constraints in customer PCB copper design apply as on OBS4**i modules. Keep Out Area is clearly marked in the mechanical drawing above.

LVIV-B2 module with internal antenna (P/N SE-NOBS-B2i-**) must be placed in the right upper corner of the host PCB. No copper pouring in all layers beneath internal antenna.

Radio Characteristics

Bluetooth

RF frequency range: 2400-2483.5MHz

Number of channels: 79

Conducted transmit power: +5dBm (+/-1dBm)

Bluetooth Low Energy

RF frequency range: 2400-2483.5MHz

Number of channels: 40

Conducted transmit power: +5dBm (+/-1dBm)

Output Power Control

It is possible to adjust LVIV-B2 conducted radio transmit output power by AT command "AT+UBTCFG=4,<pwr>. Factory default value for <pwr> is 6 (+6dBm).

<pwr> parameter	output power (max)
-12	-12dBm
-9	-9dBm
-6	-6dBm
-3	-3dBm
0	0dBm
3	+3dBm
6	+6dBm



Antenna gain

External antenna:

Max. antenna gain for external antenna: +3dBi

Please refer to [Appendix C](#) of LVIV-B2 data sheet for a list of approved external antennas

Internal antenna:

Internal antenna gain of Ignion NN01-102 is +1.7dBi_{peak} (Ignion data sheet)

Power Supply

Power Supply Input

VCC_3V3 Signal: DC power supply **input** (Pin 4):

P/N: SE-NOBS-B2*-A*: 3,3V-5,5V DC (5V nominal)

P/N: SE-NOBS-B2*-B*: 3,0V-3,6V DC (3.3V nominal)

VCC_3V3 supply voltage is different from OBS4xx modules, which have a VCC_3V3 range of min 3.0V – max 6.0V

Power Output for Level Shifter

VCC_IO Signal: DC **output** for level shifters (Pin 2):

P/N: SE-NOBS-B2*-A*: 3,0V DC

P/N: SE-NOBS-B2*-B*: 3,0V-3,6V DC – connected to VCC

VCC_IO output voltage is different from OBS4** modules, which have a fixed VCC_IO of 2.85V.

Electrical Interface

Please refer to NINA-B2 data sheet (u-blox document ubx-18006649, section 4) for I/O signal description.

Electrical interface – UART, GPIO lines, LED signals are identical to NINA-B221. There are no electronic components added.

Please note, that supply voltage is different from NINA-B2 (see above), resulting in different I/O voltage levels.



Physical Dimensions

PCB Size:	16mm x 36mm
PCB Height:	~1mm
Module height:	3.4mm
Module Weight:	~2.3gr / module

Mechanical size of LVIV-B2 module and location of SMT contacts are identical to OBS4** modules.

LVIV-B2 module have 2 rows of 18 LGA contacts on the bottom side and must be mounted in a SMT reflow process.

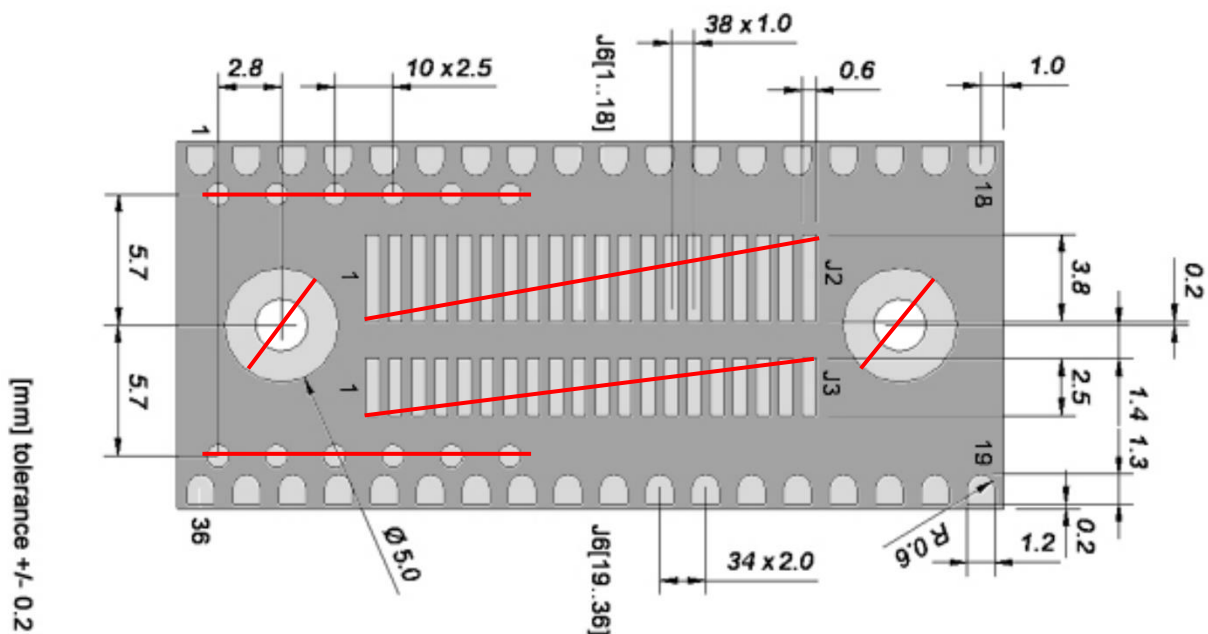

Picture – mechanical appearance for SMT pads (from OBS421 data sheet)

Mounting

LVIV-B2 modules are designed to be soldered to the main PCB with a single reflow soldering process.

LVIV-B2 modules cannot be mounted by screw mounting, as this can be done with OBS4** modules.

There are no contact rows (J2/J3 on OBS4**) and there are no mounting holes on LVIV-B2 modules.

JST connector (J8 for OBS421) is not available for LVIV-B2.



ESD Handling Precautions

As the risk of electrostatic discharge in the RF transceivers and antennas of the module is of particular concern, standard ESD safety practices are prerequisite.

Consider also:

- When connecting test equipment or any other electronics to the module (as a standalone or PCB-mounted device), the first point of contact must always be to local GND.
- Before mounting an external antenna, connect the device to ground.
- When handling the RF pin, do not touch any charged capacitors. Be especially careful when handling materials like antennas, coaxial cables, soldering irons, or any other materials that can develop charges.
- To prevent electrostatic discharge through the RF input, do not touch any exposed antenna area. If there is any risk of the exposed antenna being touched in an unprotected ESD work area, be sure to implement proper ESD protection measures in the design.

Soldering

LVIV-B2 series modules are surface mount modules supplied on a FR4-type PCB with gold-plated connection pads. The modules are produced in a lead-free process using lead-free soldering paste.

The thickness of solder resist between the top-side of the host PCB and the bottom-side of the LVIV-B2 series module must be considered for the soldering process.

LVIV-B2 series modules are compatible with industrial reflow profile for RoHS solders, and "No Clean" soldering paste is strongly recommended.

The reflow profile used is dependent on the thermal mass of the entire populated PCB, the heat transfer efficiency of the oven, and the particular type of solder paste that is used. The optimal soldering profile must be trimmed for the specific process and PCB layout.

Module is qualified for reflow soldering only.

If the host PCB needs to be soldered two (2) times, LVIV-B2 module must be soldered in the second pass.

Manual soldering is not possible, as the contacts are beneath the module (LGA style).

Only one (1) SMT soldering process is allowed for LVIV-B2 modules.



Recommended Temperature Profile

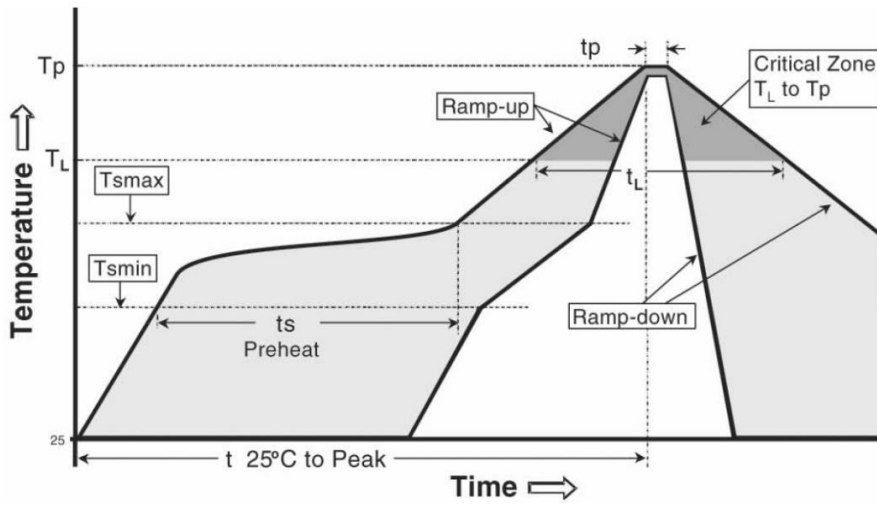

Process Paramter	Description	Unit	Value
pre-heat	ramp up rate to T_{SMIN}	K/s	3
	T_{SMIN}	°C	150
	T_{SMAX}	°C	200
	t_s (from +25°C)	s	150
peak	t_s (pre-heat)	s	60 to 120
	T_L	°C	217
	t_L (time above T_L)	s	40 to 60
cooling	T_P (absolute max)	°C	245
	ramp-down from T_L	K/s	4
	allowed soldering cycles		1
	lower value of T_P and slower ramp down rate (2 – 3 °C/sec) is preferred		

Environmental Information

RoHS directive

LVIV-B2 modules comply with the requirements of

Directive 2011/65/EU (RoHS 2)

Directive 2015/863/EU (RoHS 3)

REACH directive

LVIV-B2 modules comply with the requirements of

Regulation 1907/2006 (219)

Flammability

LVIV-B2 modules comply with UL94-V0



Product Label Information

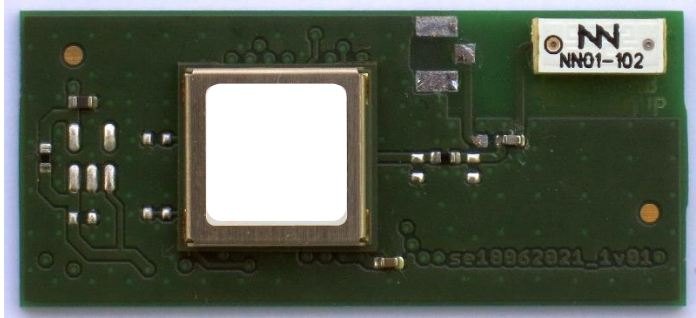

Picture 7 – product label placement

LVIV-B2 Modules are marked by a product label that shows:

FCC ID and IC ID

part number for the variant

production date information.

The label is placed on top of the RF shielding.

Label content is defined in a separate document “LVIV-B2_series_label_information.pdf”



Qualification and Approvals

LVIV-B2 series modules will be approved as a single modular transceiver for different countries and regions.

- Europe RED
- Canada IC
- USA FCC
- Japan MIC

European Union regulatory compliance

For information about the regulatory compliance of LVIV-B2 series modules against requirements and provisions in the European Union, see the LVIV-B2 Declaration of Conformity.

Radio Equipment Directive (RED) 2014/53/EU

LVIV_B2 series modules comply with the essential requirements and other relevant provisions of Radio Equipment Directive (RED) 2014/53/EU.

Output power limitation

The Radio Equipment Directive requires radio transmitters that have an Equivalent Isotropically Radiated Power (EIRP) of 10 dBm or more, to either implement an adaptivity feature or reduce its medium utilization.

LVIV-B2 series modules are based on u-blox NINA-B221 module, which supports multiple radio protocols such as classic Bluetooth and Bluetooth low energy.

Since Bluetooth low energy does not support either adaptivity or reduced medium utilization, a LVIV-B2 Bluetooth LE implementation on the European market must have an EIRP of less than 10 dBm.

In the European market, it is the end-product manufacturer that must ensure that these limitations are followed. If the LVIV-B2 module integrator is not the end-product manufacturer, the module integrator must make sure that this information is shared with the end product manufacturer.

EIRP is calculated as:

$$\text{EIRP(dBm)} = \text{PTX(dBm)} - \text{L(dB)} + \text{GTX(dBi)}$$

where, PTX is the output power of the transmitter, L is the path loss of the transmission line between the transmitter and antenna, and GTX is the maximum gain of the transmit antenna.

Consider the following for each of these components:



Output power:

o Output power setting of the LVIV-B2 module - An end product user must not be able to increase the setting above the 10 dBm EIRP limit by sending configuration commands, etc.

o the operating temperature of the end product – The output power of a transmitter is typically increased as the ambient temperature is lowered. The operating temperature range of LVIV-B2 is -40 to +85 °C, and across this range the output power can typically vary by 1 dB.

The output power at the lowest operating temperature (yielding the highest output power) must be considered for the EIRP calculation.

- Path loss – Long antenna cables or PCB traces, RF switches, etc, attenuate the power reaching the antenna. This path loss should be measured and taken into consideration for the EIRP calculation.
- Antenna gain - The maximum gain of the transmit antenna must be considered for the EIRP calculation.

Compliance with the RoHS directive

LVIV-B2 series modules comply with the Directive 2011/65/EU (EU RoHS 2) and its amendment Directive (EU) 2015/863 (EU RoHS 3).



United States (FCC)

LVIV-B2 series modules have received Federal Communications Commission (FCC) CFR47 Telecommunications, Part 15 Subpart C "Intentional Radiators" in accordance with Part 15.247 and Modular Transmitter approval in accordance with Part 15.212. Provided no changes or modifications are made to the module circuitry, the modular approval of the LVIV-B2 series allows an end-product manufacturer to integrate the module into an existing product without the need for additional testing or equipment authorization for the transmitter function in LVIV-B2 modules. Changes or modifications could void the user's authority to operate the equipment. The end-user must comply with all instructions provided by the Grantee, which describe the installation and/or operating conditions necessary for compliance. The finished product is required to comply with all applicable FCC equipment authorizations regulations, requirements, and equipment functions that are not associated with the transmitter module. For example, compliance against regulations for other transmitter components within the host product must be demonstrated, and the requirements for unintentional radiators (Part 15 Subpart B "Unintentional Radiators"), such as digital devices, computer peripherals, radio receivers, etc., must also be met. Any additional authorization requirements (for verification or conformity declarations) that are not related to transmitter functions in the module transmitter may also contain any required digital logic functions.

FCC compliance

LVIV-B2 series modules are intended for OEM integrators only. The end product must be professionally installed in way that only authorized antennas can be used. The (OEM) Integrator must assure compliance of the entire end product that includes the integrated LVIV-B2 module. For compliance with FCC Part 15B (§15.107, and if applicable the §15.109 regulations, the host manufacturer is required to show conformant operation of the installed product. The product evaluation should also confirm that the intentional emissions (15C) from the module are compliant during (fundamental and out-of-band) transmission. Additionally, the integrator must apply the appropriate equipment authorization (verification) for the new host device as defined in §15.101. The details of the module implementation in host device are confidential. Integrators are reminded not to share the installation instructions of the module to any end-user of the final host device. The final host device, into which this RF module is integrated must be labeled with an auxiliary label stating the FCC ID of the RF Module, such as:

"Contains FCC ID: 2A54FLVIVB2"

"This device complies with part 15 of the FCC rules. Operation is subject to the following two conditions:

1. This device may not cause harmful interference, and
2. This device must accept any received interference, including interference, that might cause undesired operation."



"Changes or modifications to this unit not expressly approved by the party responsible for compliance could void the user's authority to operate the equipment."

The Integrator is responsible for satisfying SAR/ RF exposure requirements once the module has been integrated into the host device.

△ LVIV-B2 series modules are intended for OEM integrators only. End-products that include LVIV-B2 modules must be professionally installed in such a way that only the authorized antennas listed included in the pre-approved antennas list can be used.

△ If the antenna connector is easily accessible to the end-user, the integrator has to fix the antenna in such way, that the end user can not replace the antenna. Please refer to KDB 353028 for further information

△ The details of the module implementation in the host device (end-product) should remain confidential. Integrators are reminded not to share the module installation instructions to the end-user of the end-product (host device).

△ Any changes or modifications NOT explicitly APPROVED by SE Spezial-Electronic GmbH may invalidate compliance with FCC rules part 15 and subsequently void the user's authority to operate the equipment.

△ Any changes to hardware, hosts, or co-location configuration may require new radiated emission and SAR evaluation and/or testing.

△ The end-product manufacturer (OEM integrator) is responsible for verifying the end-product compliance with FCC Part 15, subpart B limits for unintentional radiators through an accredited test facility.

Model P/N	FCC ID
SE-NOBS-B2i-A3	2A54FLVIVB2
SE-NOBS-BXi-A3	2A54FLVIVB2
SE-NOBS-B2i-B3	2A54FLVIVB2
SE-NOBS-B2X-B3	2A54FLVIVB2

2.2.2 FCC statement

The single-modular transmitter supported in LVIV-B2 modules is a self-contained, physically delineated component for which compliance can be demonstrated independent of the host operating conditions.



The transmitter complies with all eight requirements of FCC § 15.212(a)(1), as summarized below:

1. The radio elements of the radio frequency circuitry is shielded.
2. The module has buffered modulation/data inputs to ensure that the device complies with Part 15 requirements with any type of input signal.
3. The module includes power supply regulation in the module.
4. The module contains a permanently attached antenna.
5. The module demonstrates compliance in a stand-alone configuration.
6. The module includes a permanently affixed FCC ID label.
7. The module complies with all specific rules applicable to the transmitter, including all conditions provided in the integration instructions by the grantee.
8. The module complies with RF exposure requirements.

This equipment has been tested and found to comply with the limits for a Class B digital device, pursuant to part 15 of the FCC Rules. These limits are designed to provide reasonable protection against harmful interference in a residential installation. This equipment generates uses and can radiate radio frequency energy and, if not installed and used in accordance with the instructions, may cause harmful interference to radio communications. However, there is no guarantee that interference will not occur in a particular installation. If this equipment does cause harmful interference to radio or television reception, which can be determined by turning the equipment off and on, the user is encouraged to try to correct the interference by one or more of the following measures:

- Reorient or relocate the receiving antenna.
- Increase the separation between the equipment and receiver.
- Connect the equipment into an outlet on a circuit different from that to which the receiver is connected.
- Consult the dealer or an experienced radio/TV technician for help.

RF-exposure

This device complies with the FCC radiation exposure limits set forth for an uncontrolled environment.



LVIV-B2 modules are approved for installation into mobile and/or portable host platforms and must not be co-located or operating in conjunction with any other antenna or transmitter – except in accordance with FCC multi-transmitter guidelines. End-users must be provided with transmitter operating conditions for satisfying RF Exposure compliance.

To ensure that the output power remains below the SAR evaluation Exemption limits defined in SAR test exclusion limits in KDB 447498 D01v06, customer applications integrating the LVIV-B2 modules must include a separation distance of at least 5 mm between the user (or bystander) and the antenna (or radiating element).

End-product compliance

Application designs must conform to the following requirements:

- Any changes to hardware, hosts or co-location configuration may require new radiated emission and SAR evaluation and/or testing.
- Only authorized antenna(s) may be used.
- Any notification to the end user about how to install or remove the integrated radio module is NOT allowed.
- The approval of the modular transmitter in LVIV-B2 series modules does not exempt the end product from being evaluated against any applicable regulatory demands. The evaluation of the end product shall be performed with the LVIV-B2 module installed and operating in a way that reflects the intended use case of the end product. The upper frequency measurement range for the end product evaluation is the 5th harmonic of 2.4 GHz as declared in 47 CFR Part 15.33 (b)(1).
- The following requirements apply to all products that integrate a radio module:
 - o Subpart B - UNINTENTIONAL RADIATORS To verify that the composite device of host and module complies with the requirements of FCC part 15B the integrator shall perform sufficient measurements using equipment compliant with ANSI 63.4-2014.
 - o Subpart C - INTENTIONAL RADIATORS The integrator must carry out sufficient verification measurements, using compliant ANSI 63.10-2013 equipment, to validate that the fundamental and out-of-band emissions of the transmitter part of the composite device comply with the requirements of FCC part 15C.
- When the items listed above are fulfilled the host manufacturer can use the authorization procedures presented in Table 1 of 47 CFR Part 15.101.



Canada (ISED)

△ LVIV-B2 series modules are certified for use in accordance with the Canada under Innovation, Science and Economic Development

Canada (ISED)

Radio Standards Specification (RSS) RSS247 Issue 2 and RSSGen. 2.3.1 Labeling and user information requirements. A final host device, into which this RF Module is integrated, must be labeled with an auxiliary label stating the IC of the RF Module, such as:

“Contains transmitter module IC: 28382-LVIVB2”

Le périphérique hôte final, dans lequel ce module RF est intégré doit être étiqueté avec une étiquette auxiliaire indiquant le CI du module RF, tel que

“Contient le module émetteur IC: 28382-LVIVB2”

This device contains licence-exempt transmitter(s)/receiver(s) that comply with Innovation, Science and Economic Development Canada’s licence-exempt RSS(s). Operation is subject to the following two conditions:

1. This device may not cause interference.
2. This device must accept any interference, including interference that may cause undesired operation of the device.

L’émetteur/récepteur exempt de licence contenu dans le présent appareil est conforme aux CNR d’Innovation, Sciences et Développement économique Canada applicables aux appareils radio exempts de licence. L’exploitation est autorisée aux deux conditions suivantes :

1. L’appareil ne doit pas produire de brouillage;
2. L’appareil doit accepter tout brouillage radioélectrique subi, même si le brouillage est susceptible d’en compromettre le fonctionnement.

Model P/N (HVIN)	IC ID
SE-NOBS-B2i-A3	28382-LVIVB2
SE-NOBS-BXi-A3	28382-LVIVB2
SE-NOBS-B2i-B3	28382-LVIVB2
SE-NOBS-B2X-B3	28382-LVIVB2

RF-exposure

All transmitters regulated by IC must comply with RF exposure requirements listed in RSS-102 - Radio Frequency (RF) Exposure Compliance of Radiocommunication Apparatus (All Frequency Bands). This module is approved for installation into mobile and/or portable host platforms and must not be co-located or operating in conjunction with any



other antenna or transmitter except in accordance with Industry Canada's multi-transmitter guidelines. End-users must be provided with transmitter operating conditions for satisfying RF Exposure compliance. To ensure that the output power remains below the SAR evaluation Exemption limits defined in RSS102 issue 5, customer applications integrating the LVIV-B2 modules must include a separation distance of at least 15 mm between the user (or bystander) and the antenna (or radiating element). Japan radio equipment compliance



Japan radio equipment compliance

Compliance statement

LVIV-B2 series modules comply with the Japanese Technical Regulation Conformity Certification of Specified Radio Equipment (ordinance of MPT N°. 37, 1981), Article 2, Paragraph 1:

- Item 19 "2.4 GHz band wide band low power data communication system".

End product labelling requirement

End products based on LVIV-B2 series modules and targeted for distribution in Japan must be affixed with a label with the "Giteki" marking, as shown in Figure 7. The marking must be visible for inspection.

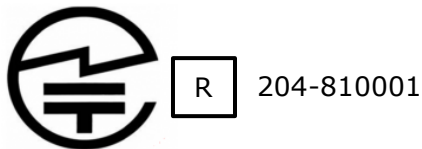

Figure 7 – Giteki mark, R and the NINA-B221 MIC certification number

End product user manual requirement

As the MIC ID is not included on the LVIV-B2 marking, the end product manufacturer must include a copy of the LVIV-B2 Japan Radio Certificate in the end product technical documentation.

For information about compliance of the NINA-B221 module with the Giteki certification, see the NINA-B2 series system integration manual.



UL Marking

LVIV-B2 PCB is UL 94V-0 marked.

Prototypes and first production lots have the UL 94V-0 marking on the bottom side, embedded into the solder stop print:

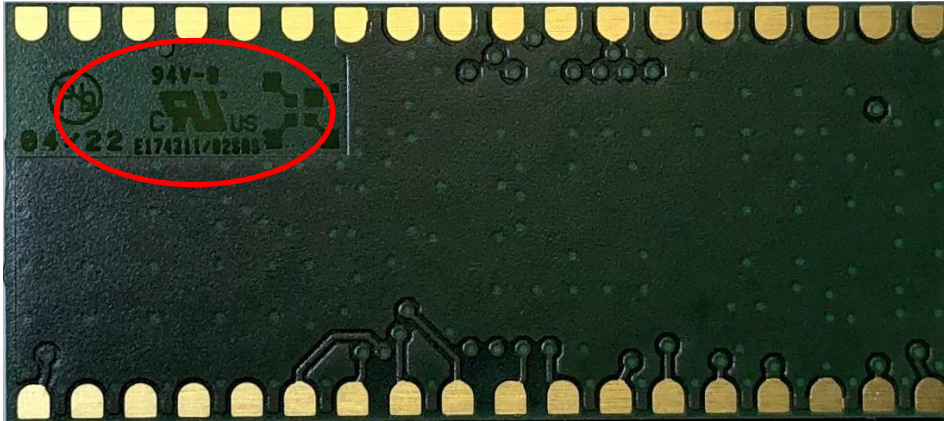

All other production lots starting from 23/10 and later will have it on the Top side silk print of the PCB:





Radio Test Access

For additional radio tests, a dedicated radio test firmware can be provided under NDA. The radio test firmware can be loaded to RAM only.

To load the firmware, the customer needs to access the SYS-BOOT pin of NINA-B221.

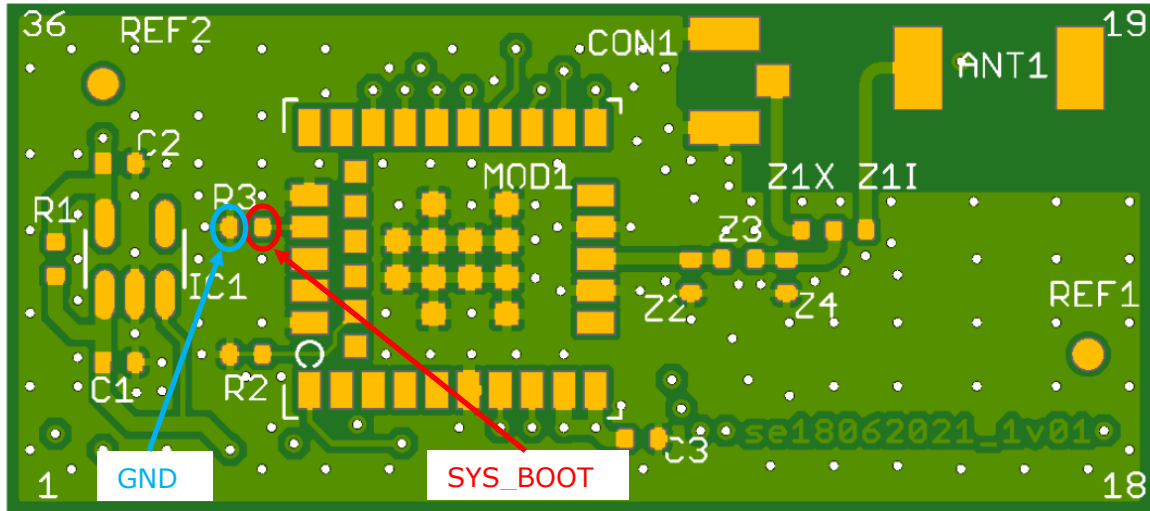

The test point is available on TOP side of the PCB marked as "R3". A GND pin is close by, so the SYS-BOOT pin can easily be grounded by a tweezer, if needed.



Document Revision History

Revision	Date	Author	Description
R01	10.03.'22	Foraita	Corrected wording Renamed product family name to LVIV-B2 Released (based on DRAFT 0.8)
	16.03.'22	Foraita	Added T&R information
	21.03.'22	Foraita	Replaced product photo
	23.03.'22	Foraita	Replaced picture for mech. Dimensions Added weight information Added Environmental Information
	24.03.'22	Foraita	Added Certifications Re-arranged topics
R02	25.03.'22	Foraita	Added table for module comparison Changed document revision numbering from 1.0 to R02
	30.03.'22	Foraita	Added drawings for product identification Added topic "Label Information"
R03	06.04.'22	Foraita	Added FCC and IC information new wording in Abstract Added soldering information
R04	26.04.'22	Foraita	Corrected Product Label Content Corrected F/W version identification (4.0.0-003)
	11.05.'22	Foraita	Corrected Product Label Information, switch from DMC to plain text Added document internal links Corrected/improved wording
	16.05.'22	Foraita	Added Schematics and Product Photos
	17.05.'22	Foraita	New list of approved antennas
R05	30.05.'22	Foraita	Added SYS-BOOT pin information
	31.05.'22		Added product label examples
R06	15.07.'22	Foraita	Revised FCC/IC Approval Section Replace "family" by "series"
R07	16.08.'22	Foraita	Removed Schematics, corrected wording in list of antennas
R08	08.09.'22	Foraita	Added new Photo to Tape and Reel Info
R09	13.02.'23	Foraita	Added EN 62479:2010 to RED DoC
R10	16.05.'23	Foraita	Updated product pictures and labelling info, added section "UL Marking"

Manufacturer Contact

SE Spezial-Electronic GmbH
Friedrich-Bach-Strasse 1
31675 Bueckeburg
Germany

+49 5722 203 0

www.spezial.com

Technical Support

support@spezial.com



Appendix A: u-blox Documentation NINA-B2 and OBS421

Document type	Description	NINA-B22*	OBS4**
Data Sheet	Physical description of the module, including approval information	https://www.u-blox.com/en/ubx-viewer/view/NINA-B2_DataSheet_UBX-18006649?url=https%3A%2F%2Fwww.u-blox.com%2Fsites%2Fdefault%2Ffiles%2FNINA-B2_DataSheet_UBX-18006649.pdf	https://www.u-blox.com/en/docs/UBX-15016247
Integration Manual	Design guidelines for hardware design	https://www.u-blox.com/en/ubx-viewer/view/NINA-B2_SIM_UBX-18011096?url=https%3A%2F%2Fwww.u-blox.com%2Fsites%2Fdefault%2Ffiles%2FNINA-B2_SIM_UBX-18011096.pdf	https://www.u-blox.com/en/docs/UBX-15016247
AT Command Reference	AT Commands Reference	https://www.u-blox.com/en/ubx-viewer/view/u-connectXpress-ATCommands-Manual_UBX-14044127?url=https%3A%2F%2Fwww.u-blox.com%2Fsites%2Fdefault%2Ffiles%2Fu-connectXpress-ATCommands-Manual_UBX-14044127.pdf	https://www.u-blox.com/en/docs/UBX-15013158
DoC	RED Declaration of Conformity	https://www.u-blox.com/en/docs/UBX-18007187	https://www.u-blox.com/en/docs/UBX-15014547
AT Commands for GATT Layer	Additional AT Commands for GATT Layer handling	n.a. included in AT Command Manual	https://www.u-blox.com/en/docs/UBX-15013159
Soldering Instructions	Specific soldering instructions	n.a. included in System Integration Manual	https://www.u-blox.com/en/docs/UBX-17001692
AT Command Application Note	Use examples	https://www.u-blox.com/en/ubx-viewer/view/u-connectXpress_UserGuide_UBX-16024251?url=https%3A%2F%2Fwww.u-blox.com%2Fsites%2Fdefault%2Ffiles%2Fu-connectXpress_UserGuide_UBX-16024251.pdf	n.a.
Tape&Reel Information u-blox	Tape&Reel Specification	https://www.u-blox.com/sites/default/files/ublox-PackageInfo_Reference_UBX-14001652.pdf	
Label Information	Definition of product label content	LVIV-B2_series_label_information.pdf	



Appendix B: Tape & Reel Packaging Information

LVIV-B2 is available in Tape & Reel Packaging. Number of modules in a standard reel is 250pcs.

Reel Information can be found in ["u-blox-PackageInfo Reference_UBX-14001652.pdf"](#) in section 2.1.5, Reel Type E.

LVIV-B2 Module Orientation as follows:

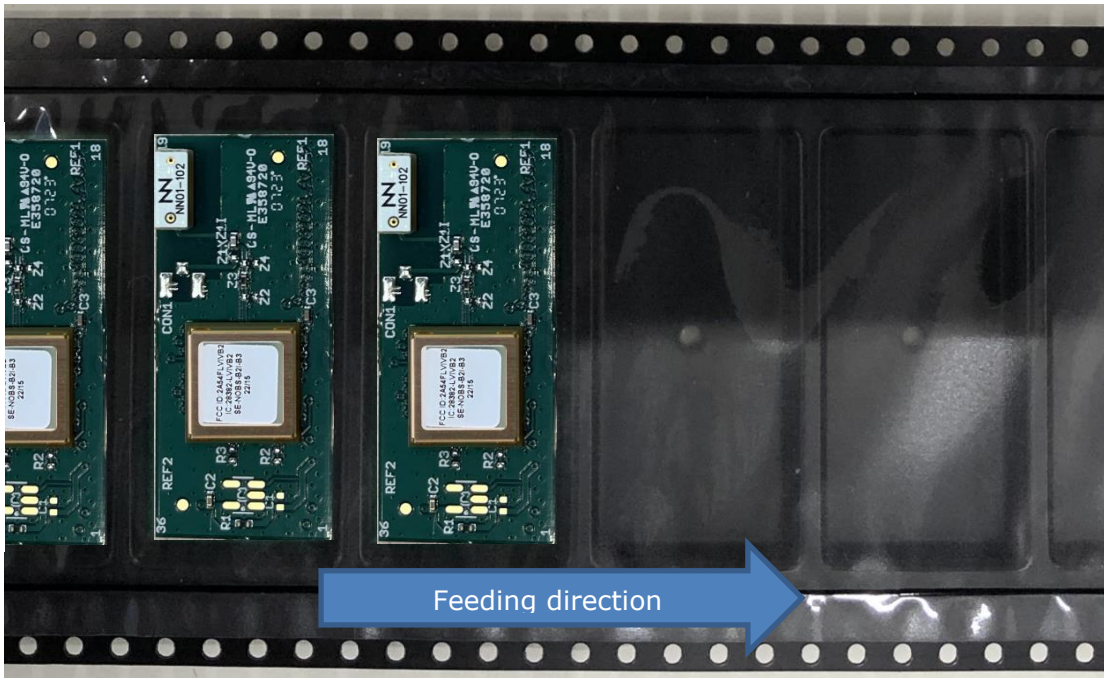

Tap and Reel Orientation of LVIV-B2

Orientation of LVIV-B2 family modules is the same as for u-blox OBS4** modules.



Appendix C: Approved antennas

This chapter gives an overview of the different external antennas that can be used together with the module.

△ This radio transmitter IC: 28382-LVIVB2 has been approved by Industry Canada to operate with the antenna types listed below with the maximum permissible gain and required antenna impedance for each antenna type indicated. Antenna types not included in this list, having a gain greater than the maximum gain indicated for that type, are strictly prohibited for use with this device.

△ Cet émetteur radio IC: 28382-LVIVB2 été approuvé par Industry Canada pour fonctionner avec les types d'antenne énumérés ci-dessous avec le gain maximum autorisé et l'impédance nécessaire pour chaque type d'antenne indiqué. Les types d'antenne ne figurant pas dans cette liste et ayant un gain supérieur au gain maximum indiqué pour ce type-là sont strictement interdits d'utilisation avec cet appareil.

For each antenna, the "Approvals" field defines in which test reports the antenna is included. Definitions of the «Approvals» field are:

- FCC - The antenna is included in the FCC test reports and thus approved for use in countries that accept the FCC radio approvals, primarily US. If the integrator decides for a screw-on antenna (with RP-SMA connector)., it must be assured that the end user can not replace the antenna. For further details please refer to **KDB 353028**
- IC - The antenna is included in the IC (Industrie Canada) test reports and thus approved for use in countries that accept the IC radio approvals, primarily Canada.
- RED - The antenna is included in the ETSI test reports and thus approved for use in countries that accept the Radio Equipment Directive, primarily the European countries.
- MIC - The antenna is included in the Japanese government affiliated MIC test reports and thus approved for use in the Japanese market.

In general, antennas with SMD connection, Reverse Polarity SMA connector (RP-SMA) or U.FL connector are included in FCC, IC, RED and MIC radio tests. The antennas with SMA connector are included in RED and MIC radio tests but not in the FCC or IC due to FCC/IC regulations.

The external antennas are connected to the board through U.FL connectors. Some antennas are connected directly to the U.FL connector of the board while some are connected using an SMA or reversed polarity SMA connector through a short U.FL to SMA or reversed polarity SMA adapter cable.

Onboard antenna (SE-NOBS-B2i-**)

This antenna is the onboard component used in SE-NOBS-B2i-** modules. Please check LVIV-B2 Data Sheet and LVIV-B2 Integration Manual for correct layout.



Antenna Name	Type	Manufacturer	Comment	Peak Gain	Approval
COMPACT REACH Xtend™ (NN01-102)	O	Ignion	(internal antenna for P/N SE-NOBS-B2j-**))	+1.7dBi	FCC, IC, RED, MIC

External antennas with U.FL connector

Antennas that can be mounted inside of a plastic housing. No shielding lacquer or fiber inforced housings allowed. Mounting instructions can be found in the antenna manufacturer’s product documentation.

Antenna Name	Type	Manufacturer	Comment	Peak Gain	Approval
InSide 2400 Triangular	I	ProAnt (Abracon)	Patch, 10 cm cable/U.FL	+3.0dBi	FCC, IC, RED, MIC
Dromus (SRF2W012)	I	Antenova	Patch, 10 cm cable/U.FL	+3.0dBi	FCC, IC, RED, MIC
Amoris (SRF2W021)	I	Antenova	Patch, 10 cm cable/U.FL	+2.8dBi	FCC, IC, RED, MIC
InSide WLAN	I	ProAnt (Abracon)	Patch, 10 cm cable/U.FL	+3.0dBi	FCC, IC, RED, MIC
InSide WLAN Square	I	ProAnt (Abracon)	Patch, 10 cm cable/U.FL	+3.0dBi	FCC, IC, RED, MIC

External antennas with U.FL connector

Fixed Antennas that can be used on outside of metal enclosures.

Antenna Name	Type	Manufacturer	Comment	Peak Gain	Approval
Ex-IT 2400 - MHF 28-001	S	ProAnt (Abracon)	Monopole 10 cm cable/U.FL	+3.0dBi	FCC, IC, RED, MIC
Ex-IT WLAN - MHF 28-001	S	ProAnt (Abracon)	Monopole 10 cm cable/U.FL	+3.0dBi	FCC, IC, RED, MIC
Ex-IT 2400 - MHF 70-001	S	ProAnt (Abracon)	Monopole 10 cm cable/U.FL	+3.0dBi	FCC, IC, RED, MIC
Outside 2400	S	ProAnt (Abracon)	Patch 10 cm cable/U.FL	+3.0dBi	FCC, IC, RED, MIC

External antennas with SMA connector

Removable Antennas that can be used on outside of metal enclosures. Standard SMA connector. For FCC, IC only allowed for professional/industrial use.

Antenna Name	Type	Manufacturer	Comment	Peak Gain	Approval
FlatWhip-2400	S	ProAnt (Abracon)	Monopole SMA	+3.0dBi	RED, MIC
Ex-IT 2400 - SMA 28-001	S	ProAnt (Abracon)	Monopole SMA	+3.0dBi	RED, MIC
Ex-IT WLAN - SMA 28-001	S	ProAnt (Abracon)	Monopole SMA	+3.0dBi	RED, MIC
Ex-IT 2400 - SMA 70-002	S	ProAnt (Abracon)	Monopole SMA	+3.0dBi	RED, MIC
GW.26.0111	S	Taoglas	Monopole SMA	+2.0dBi	RED, MIC



External antennas with RP-SMA connector

Removable Antennas that can be used on outside of metal enclosures. Reversed Polarity SMA connector. For FCC, IC only allowed for professional/industrial use.

Antenna Name	Type	Manufacturer	Comment	Peak Gain	Approval
Ex-IT 2400 - RP-SMA 28-001	S	ProAnt (Abracon)	Monopole RP-SMA	+3.0dBi	FCC, IC, RED, MIC
Ex-IT 2400 Foldable - RP-SMA	S	ProAnt (Abracon)	Monopole RP-SMA	+3.0dBi	FCC, IC, RED, MIC
Ex-IT WLAN - RP-SMA 28-001	S	ProAnt (Abracon)	Monopole RP-SMA	+3.0dBi	FCC, IC, RED, MIC
Ex-IT 2400 - RP-SMA 70-002	S	ProAnt (Abracon)	Monopole RP-SMA	+3.0dBi	FCC, IC, RED, MIC
ANT-2.4-CW-RH-RPS	S	Linx	Monopole	-1.0dBi	FCC, IC, RED, MIC

Adapter Cables

U.FL to SMA adapter cable

- U.FL and SMA jack (outer thread and pin receptacle)
- 50 Ohms nominal impedance
- 0.5dB minimum cable loss
- 100mm minimum cable length
- SMA connector suitable for panel mounting

Approvals: RED, MIC

U.FL to Reverse Polarity (RP) SMA

- U.FL and RP SMA jack (outer thread and pin)
- 50 Ohms nominal impedance
- 0.5dB minimum cable loss
- 100mm minimum cable length
- SMA connector suitable for panel mounting

Approvals: FCC, IC,RED, MIC



Appendix D: Indicative Performance internal antenna (P/N: SE-NOBS-B2i-B3)

Data Throughput Classic Bluetooth SPP (all default):

Setup:

P/N SE-NOBS-B2I-B3 on test board
u-blox EVK-NONA-B222
laptop running 2 instances of s-center 6.0
distance between modules ~0.5m

Both devices using the same F/W 4.0.0, all module settings are factory defaults.

Connection is initiated by LVIV-B2 module (no security, plain SPP connection). EVK-NINA-B222 is used as „reference station“. Test was performed for more than 30 minutes.

EVK-NINA-B222 simply echoes the data (s-center/tools/data pump -> echo)
Data Throughput „Round-Loop“ is >91kbit/s

Data Throughput Classic Bluetooth SPP (3Mit/s UART):

Setup:

P/N SE-NOBS-B2I-B3 on test board
u-blox EVK-NONA-B222
laptop running 2 instances of s-center 6.0
distance between modules ~0.5m

Both devices using the same F/W 4.0.0, all module settings are factory defaults, except for UART speed set to 3Mbit/s.

Connection is initiated by LVIV-B2 module (no security, plain SPP connection). EVK-NINA-B222 is used as „reference station“. Tests were performed for more than 5 minutes (each).

- a) EVK-NINA-B222 simply echoes the data (s-center/tools/data pump -> echo)
Data Throughput „Round-Loop“ is >800kbit/s
- b) EVK-NINA-B222 simply receives and checks the data (s-center/tools/data pump -> continuous)
Data Throughput „One Direction“ is >1.25Mbit/s

Data Throughput Bluetooth Low Energy SPS:

Setup:

LVIV-B2 with internal antenna and 3.3V supply voltage
P/N SE-NOBS-B2I-B3 on test board
u-blox EVK-NINA-B222
laptop running 2 instances of s-center 6.0
distance between modules ~0.5m



Both devices using the same F/W 4.0.0, all module settings are factory defaults. LVIV-B2 acts as central. EVK-NINA-B222 acts as peripheral.

Connection is initiated by LVIV-B2 module (no security, plain SPS connection). EVK-NINA-B222 is used as „reference station“.

On both s-center sides, a continuous data stream is initiated (s-center/tools/data pump - > continuous). Test duration was some 10 minutes:

Data stream from LVIV-B2 (central) to EVK-NINA-B222 (peripheral) ~17kbit/s

Data stream from EVK-NINA-B222 (peripheral) to LVIV-B2 (central) ~13kbit/s

Range classic BT (SPP, residential road, restricted line of sight):

Setup:

P/N SE-NOBS-B2I-B3 on test board

u-blox EVK-NONA-B222

2 laptops running s-center 6.0

tested in a residential road with cars parked, fairly line of sight, modules 90cm above street level

Both devices using the same F/W 4.0.0, all module settings are factory defaults. Expected data throughput is >91kbit/s, which is very close to the physical limit, when UART is set to 115200Bd.

Average test time is 2 minutes.

- a) Max. distance without data throughput reduction (>91kbit/s): 60 m
- b) Max. distance to establish a connection and transfer data (max. throughput)
 - a. 70 m
 - b. 5-10 kbits/s





Appendix E: P/N comparison LVIV-B2 / OBS4**

OBS4** part number	LVIV-B2 part number	
	3.0 – 3.6 Vcc	3.3 – 5.5 Vcc
cB-OBS421i-24	SE-NOBS-B2i-B3	SE-NOBS-B2i-A3
cB-OBS421x-24	SE-NOBS-B2X-B3	SE-NOBS-B2X-B3
cB-OBS421i-14	SE-NOBS-B2i-B3	SE-NOBS-B2i-A3
cB-OBS421j-14	SE-NOBS-B2i-B3	SE-NOBS-B2i-A3
cB-OBS421x-14	SE-NOBS-B2X-B3	SE-NOBS-B2X-B3
cB-OBS421i-04	SE-NOBS-B2i-B3	SE-NOBS-B2i-A3
cB-OBS421j-04	SE-NOBS-B2i-B3	SE-NOBS-B2i-A3
cB-OBS421x-04	SE-NOBS-B2X-B3	SE-NOBS-B2X-B3
cB-OBS418i-04	SE-NOBS-B2i-B3	SE-NOBS-B2i-A3
cB-OBS418x-04	SE-NOBS-B2X-B3	SE-NOBS-B2X-A3
cB-OBS419i-04	SE-NOBS-B2i-B3	SE-NOBS-B2i-A3
cB-OBS419j-04	SE-NOBS-B2i-B3	SE-NOBS-B2i-A3
cB-OBS419x-04	SE-NOBS-B2X-B3	SE-NOBS-B2X-B3

In any case, the host software interface must be adapted, as LVIV-B2 uses different AT commands compared to u-blox' OBS4** modules.

LVIV-B2 is only suitable for SMT mounting

LVIV-B2 has no mounting holes

LVIV-B2 does not support J2/J3 (Samtec connector)

LVIV-B2 does not support J8 (JST connector)

LVIV-B2 does not support iAP protocol